

Clear-Flex II[®] Strip Door Installation Instructions

Diagram 1

Under Header (Lintel) Position

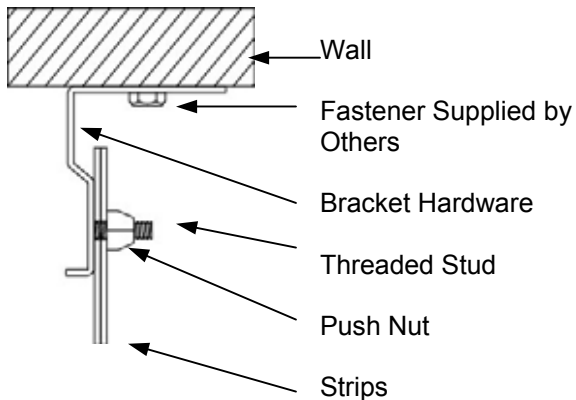

Diagram 2

Wall (Header) Position

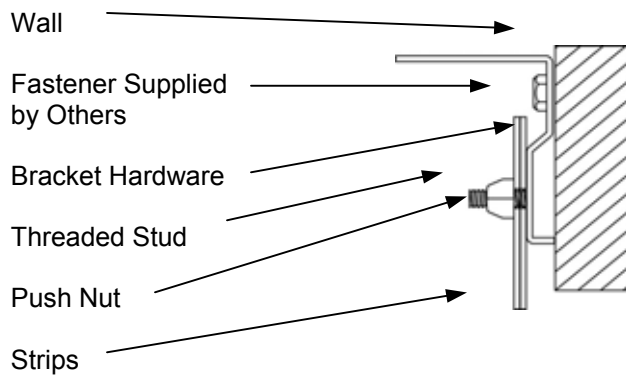
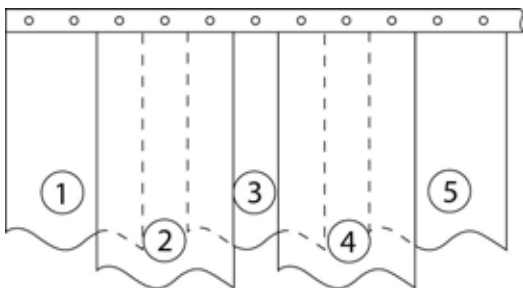

Diagram 3

Front View Strip Spacing



TOOLS NEEDED

- Pen or Pencil to Mark Drill Holes
- Drill
- 7/16" Diameter Fasteners
- Step Stool or Ladder
- Utility Knife to Cut Strips

IMPORTANT

Prior to installation, **unroll all door strips** and place them on a clean, flat surface in a warm atmosphere for a minimum of twenty-four (24) hours. This will allow the strips to return to their original form.

1. Mount the hardware bracket in either the under header or wall position shown in Diagrams 1 and 2 using appropriate fasteners supplied by others (recommended 7/16" diameter).
2. Press the door strips onto the threaded studs of the hardware bracket making certain that the concave sides are facing each other (Diagram 4). Attach strip numbers 1 and 3 (see Diagram 3) with concave side toward you, leaving desired spacing between strips as indicated by the diagram on reverse side of this sheet.

Diagram 4

3. Attach strip number 2 with concave side away from you over strip numbers 1 and 3 (Diagram 3). Press the supplied push nuts onto the threaded studs.
4. Attach all of the remaining door strips in the same manner as in Steps 2 and 3 making certain that the concave sides face each other (Diagram 4).
5. After all door strips have been attached, the strips should be trimmed to leave 1/4" of clearance from the floor surface. Your PVC door strips may be trimmed by using a common utility knife to score and then be torn by hand. **The door strips need to hang for 24 to 48 hours before final trim to allow for proper alignment.**

STRIP PLACEMENT GUIDE

PARTIAL OVERLAP

FULL OVERLAP

6" WIDE MATERIAL

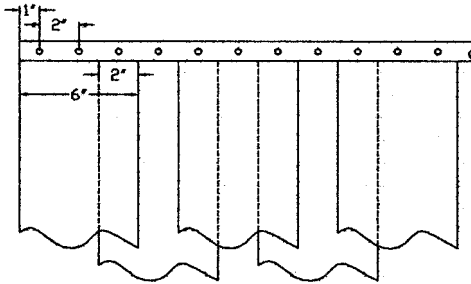

PARTIAL OVERLAP 66%

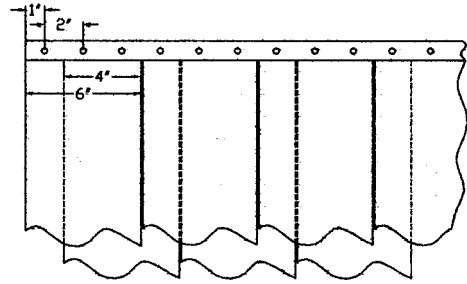

FULL OVERLAP 100%

8" WIDE MATERIAL

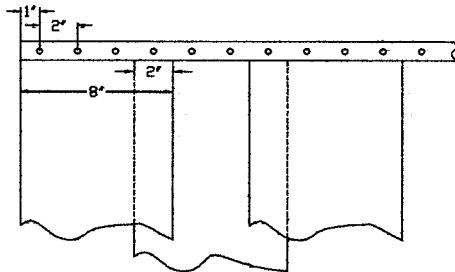

PARTIAL OVERLAP 50%

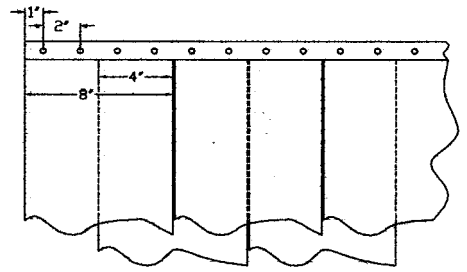

FULL OVERLAP 100%

12" WIDE MATERIAL

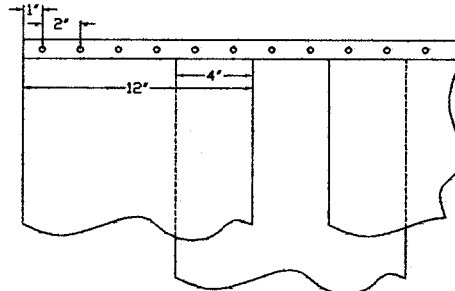

PARTIAL OVERLAP 66% (4")
PARTIAL OVERLAP 33% (2")

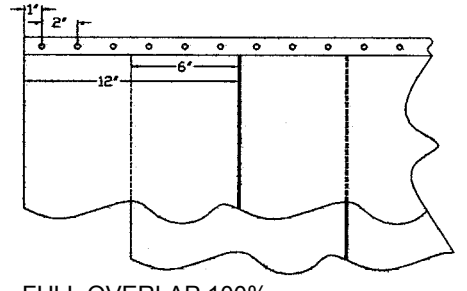

FULL OVERLAP 100%

16" WIDE MATERIAL

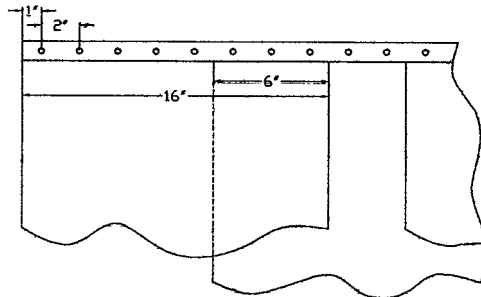

PARTIAL OVERLAP 75% (6")
PARTIAL OVERLAP 50% (4")
PARTIAL OVERLAP 25% (2")

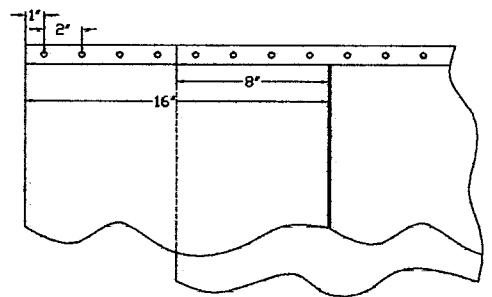

FULL OVERLAP 100%